

Angekis®

ASP-C-02

Digital Signal Processor

User Manual



Please read the User Manual carefully before use
English v1.1

Product overview

The ASP-C-02 is a high quality audio mixing system, developed for use in lecture halls, meeting rooms, houses of worship, or any other large space that needs professional audio. It consists of a Digital Signal Processor main unit with phoenix terminals and USB connectivity, as well as two HD voice hanging area microphones. It connects to speakers for instant amplification and/or a computer or recording device for further audio production.

Introduction to Center Unit

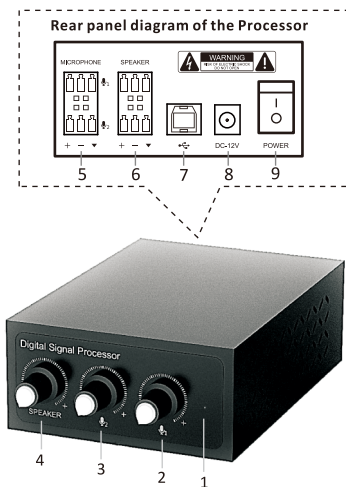

1. Indicators
2. Suspended microphone 1 sends the signal for volume adjustment
3. Suspended microphone 2 sends the signal for volume adjustment
4. Volume adjustment of speaker
5. Suspended microphone 1/
Suspended microphone 2 interface
6. Output interface of speaker
7. USB data interface
8. DC supply interface
9. Power on/off

Packing list



Digital Signal Processor
(Center Unit)
x1



Ball-shaped omnidirectional
microphone
x2

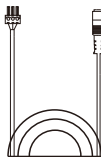

Ball-shaped omnidirectional
microphone cable
x2

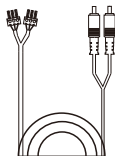

Speaker cable
x1

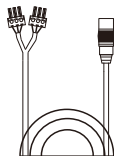

3.5 female audio
connector cable
x1

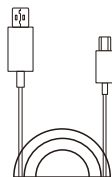

USB data cable
x1

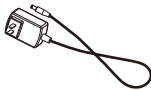

DC power adapter
x1

Installation

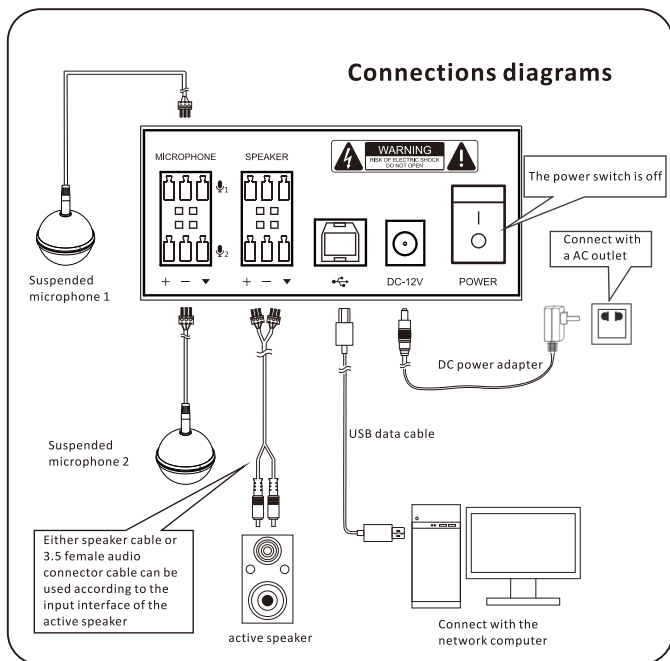

Note:

1. Connect only “+” and signal ground “▼” for single-ended signal, no need to connect “-”.
2. Connect “+” “▼” and “-” for differential signal.
3. The distance between two suspended microphones shall be more than 2m.
4. Turn on Power switch after it is well-wired according to Connection Diagram.

Operation instruction

1. Open the product package, take out all of the devices and accessories, and confirm with the packing list that all items are included.
2. Turn the power switch of the Center Unit to "off".
3. Following the Connection Diagram and the note, first connect the two ball-shaped microphones and the active speaker, then use the USB data cable to connect with the USB interface your computer, then connect the DC power adapter cable with the adapter, and finally plug the adapter into an AC outlet.
4. After everything is connected as per the Connection Diagram, turn the three volume knobs counterclockwise to the minimum volume; then turn the Power on. The Indicator should glow.
5. To start operation for an internet meeting or broadcast, first start with minimum input and output volumes. Start the connection via your preferred application (Zoom, Skype, MS Teams, etc.) and the slowly turn up the volumes of the microphones and speakers. Adjust as necessary.

Note:

The device is compatible with Windows, Mac OS, and other computer operating systems that support USB 1.1 or higher interfaces. The USB data cable can be inserted and used as a plug and play device with no extra drivers necessary.

Precautions

1. Please connect only one speaker/microphone system to your computer at a time. Operating both the ASP-C-02 and another external microphone or speaker system may cause abnormal function.
2. Please do not use a USB hub. Connect the ASP-C-02 directly to the computer.
3. After connecting the device, please check in Settings that the default input and output devices are correctly set to " ASP-C-02 " .
4. Please do not try to repair the unit on your own, as this poses an electrical shocking hazard. Please refer to your authorized dealer for repairs.
